

CG-1110 BEAKER, GRIFFIN, QUARTZ

Low form beaker made of quartz. Non-graduated with pouring spout. Beaker can be used at temperatures to 1000°C. **Please Note: Sizes other than those listed below are available. Please contact our Technical Service Department for details.**

Part Number	Capacity (mL)	Overall Height X O.D. (mm)
CG-1110-01	50	50 x 45
CG-1110-02	100	62 x 51
CG-1110-03	250	86 x 67
CG-1110-04	400	105 x 80
CG-1110-05	600	119 x 90
CG-1110-06	1000	140 x 107

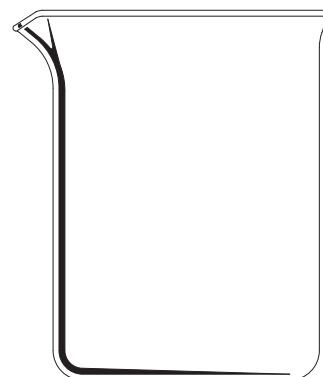

CG-1110

CGQ-4000 CRUCIBLE, QUARTZ, WITH LID

Crucible for use in temperatures up to 1000°C. Perfect for use in muffle furnace ashing procedures. Quartz material ensures sample purity for further analysis.

Part Number	Capacity (mL)	Top Diameter (mm)	Base Diameter (mm)	Height (mm)
CGQ-4000-01	15	41	15	28
CGQ-4000-02	25	47	18	30
CGQ-4000-03	40	57	20	45
CGQ-4000-04	100	62	35	67



CGQ-4000

QUARTZ PRODUCTS

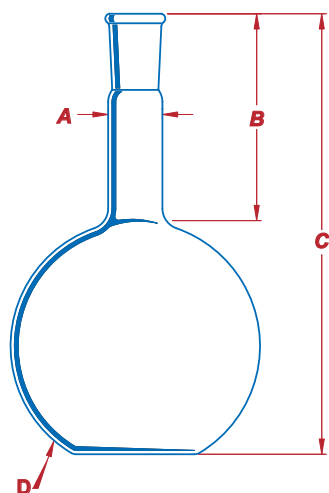

CG-1500-Q

CG-1500-Q FLASK, QUARTZ, FLAT BOTTOM, SINGLE NECK

Single neck flat bottom Quartz flask with standard taper outer joint.

Part Number	Capacity (mL)	Joint Size	"D" Diameter (mm)	"C" Height (mm)	"A x B" Neck Diameter x Length (mm)
CG-1500-Q-02	50	19/38	52	114	22 x 65
CG-1500-Q-04	100	24/40	65	128	28 x 67
CG-1500-Q-06	125	24/40	69	132	28 x 67
CG-1500-Q-08	150	24/40	74	136	28 x 67
CG-1500-Q-10	200	24/40	79	141	28 x 67
CG-1500-Q-12	250	24/40	86	147	28 x 67
CG-1500-Q-14	500	24/40	109	168	28 x 67
CG-1500-Q-16	750	29/42	124	223	34 x 107
CG-1500-Q-18	1000	29/42	136	233	34 x 107
CG-1500-Q-20	1500	29/42	149	245	34 x 107
CG-1500-Q-22	2000	29/42	162	257	34 x 107

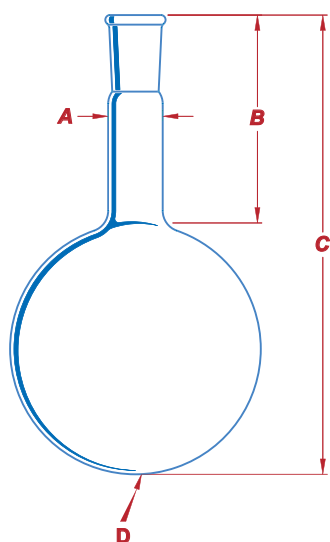

CG-1506-Q

CG-1506-Q FLASK, QUARTZ, ROUND BOTTOM, SINGLE NECK

Single neck round bottom Quartz flask with standard taper outer joint.

Part Number	Capacity (mL)	Joint Size	"D" Diameter (mm)	"C" Height (mm)	"A x B" Neck Diameter x Length (mm)
CG-1506-Q-02	50	19/38	52	117	22 x 65
CG-1506-Q-04	100	24/40	65	132	28 x 67
CG-1506-Q-06	125	24/40	69	136	28 x 67
CG-1506-Q-08	150	24/40	74	141	28 x 67
CG-1506-Q-10	200	24/40	79	146	28 x 67
CG-1506-Q-12	250	24/40	86	153	28 x 67
CG-1506-Q-14	500	24/40	109	176	28 x 67
CG-1506-Q-16	750	29/42	124	231	34 x 107
CG-1506-Q-18	1000	29/42	136	243	34 x 107
CG-1506-Q-20	1500	29/42	149	256	34 x 107
CG-1506-Q-22	2000	29/42	162	269	34 x 107

CGQ-0131 GROUND JOINT, INNER, QUARTZ

Standard taper inner joint in clear fused quartz, full length.

Part Number	Joint Size	Tubing OD (mm)
CGQ-0131-14	19/38	15.0
CGQ-0131-15	24/40	22.0
CGQ-0131-16	29/42	25.8
CGQ-0131-17	34/35	30.0
CGQ-0131-19	45/50	40.0



CGQ-0131

CGQ-0132 GROUND JOINT, OUTER, QUARTZ

Standard taper outer joint in clear fused quartz, full length.

Part Number	Joint Size	Tubing OD (mm)
CGQ-0132-14	19/38	22.2
CGQ-0132-15	24/40	28.0
CGQ-0132-16	29/42	32.0
CGQ-0132-17	34/35	36.0
CGQ-0132-19	45/50	46.0

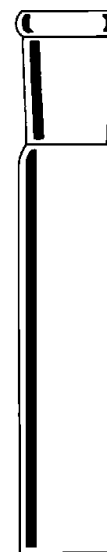

CGQ-0132

CGQ-0133 SPHERICAL JOINT, BALL MEMBER, QUARTZ

Clear fused quartz ball joint. For clamps see CG-150.

Part Number	Joint Size	Clamp Size	Tubing OD (mm)
CGQ-0133-03	12/5	12	7.5
CGQ-0133-05	18/9	18	11.8
CGQ-0133-07	28/15	28	18.0
CGQ-0133-09	35/25	35	28.8



CGQ-0133

QUARTZ PRODUCTS

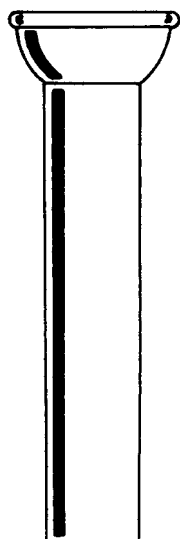

CGQ-0134

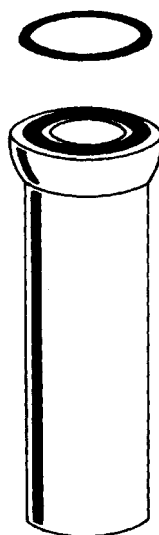

CGQ-0135

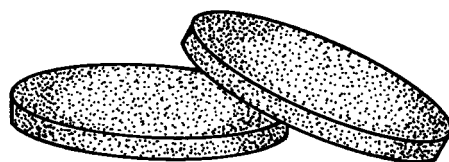

CGQ-0207

CGQ-0134 SPHERICAL JOINT, SOCKET MEMBER, QUARTZ

Clear fused quartz socket joint. For clamps see CG-150.

Part Number	Joint Size	Clamp Size	Tubing OD (mm)
CGQ-0134-03	12/5	12	7.5
CGQ-0134-05	18/9	18	11.8
CGQ-0134-07	28/15	28	18.0
CGQ-0134-09	35/25	35	28.8

CGQ-0135 O-RING JOINT, FLAT, QUARTZ

Clear fused quartz o-ring joint. Mating surface is formed so that quartz joints can be connected directly to CG-124 borosilicate o-ring joints. For clamps see CG-150.

Part Number	ID (mm)	Tube OD (mm)	O-Ring Size	Clamp Size
CGQ-0135-02	7	9.5	111	18
CGQ-0135-03	9	12.0	112	18
CGQ-0135-04	12	15.0	116	28
CGQ-0135-05	15	18.0	116	28
CGQ-0135-06	20	23.0	214	35
CGQ-0135-07	25	28.8	217	35
CGQ-0135-09	40	43.0	226	65
CGQ-0135-10	50	55.0	229	75

CGQ-0207 QUARTZ FRITTED DISCS

Porous fused quartz discs. Porosity sizes are as listed and are different from porosities of borosilicate discs.

Porosity	Pore Size
Medium (M)	15-40 microns
Coarse (C)	40-90 microns
Extra Coarse (XC)	150-200 microns

Part Number	Disc OD (mm)	Porosity	Part Number	Disc OD (mm)	Porosity
CGQ-0207-01	10	M	CGQ-0207-10	25	M
CGQ-0207-02	10	C	CGQ-0207-11	25	C
CGQ-0207-03	10	XC	CGQ-0207-12	25	XC
CGQ-0207-04	15	M	CGQ-0207-13	30	M
CGQ-0207-05	15	C	CGQ-0207-14	30	C
CGQ-0207-06	15	XC	CGQ-0207-15	30	XC
CGQ-0207-07	20	M	CGQ-0207-19	40	M
CGQ-0207-08	20	C	CGQ-0207-20	40	C
CGQ-0207-09	20	XC	CGQ-0207-21	40	XC

QUARTZ PRODUCTS

CGQ-0310 GRADED SEAL, QUARTZ TO BOROSILICATE

Graded seals have 3" of quartz sealed to 4" of borosilicate.

Part Number	ID x OD (mm)	Part Number	ID x OD (mm)
CGQ-0310-01	2 x 4	CGQ-0310-11	12 x 14
CGQ-0310-02	3 x 5	CGQ-0310-12	13 x 15
CGQ-0310-03	4 x 6	CGQ-0310-13	14 x 16
CGQ-0310-04	5 x 7	CGQ-0310-14	15 x 17
CGQ-0310-05	6 x 8	CGQ-0310-15	16 x 18
CGQ-0310-06	7 x 9	CGQ-0310-16	17 x 19
CGQ-0310-07	8 x 10	CGQ-0310-17	18 x 20
CGQ-0310-08	9 x 11	CGQ-0310-18	20 x 22
CGQ-0310-09	10 x 12	CGQ-0310-20	22 x 25
CGQ-0310-10	11 x 13	CGQ-0310-21	25 x 28
		CGQ-0310-22	27 x 30

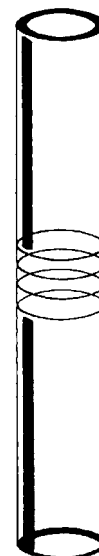

CGQ-0310

CGQ-0425 STOPCOCK, QUARTZ, STRAIGHT BORE, TEFLON PLUG

Straight bore stopcock made from clear fused quartz. For replacement Teflon plugs see CG-424.

Part Number	Bore Size (mm)	Plug Size	Sidearm OD (mm)
CGQ-0425-01	2	11/25	8
CGQ-0425-02	4	15.2/30	10

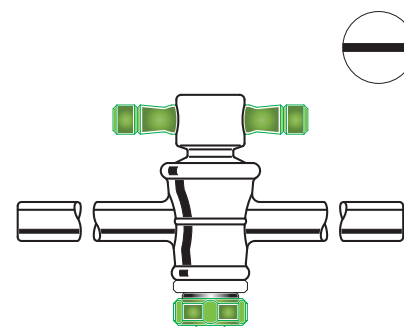

CGQ-0425

CGQ-0600 PLATE GLASS, DISC, QUARTZ

Commercial quality ground and polished clear fused quartz discs. Edges have a ground finished on all sizes. **SIZES OTHER THAN THOSE LISTED ARE AVAILABLE. PLEASE CALL FOR DETAILS.**

Part Number	Dia (in)	Thickness (in)	Part Number	Dia (in)	Thickness (in)
CGQ-0600-01	1	1/16	CGQ-0600-13	4	1/16
CGQ-0600-02	1	1/8	CGQ-0600-14	4	1/8
CGQ-0600-03	1	1/4	CGQ-0600-15	4	1/4
CGQ-0600-04	1.5	1/16	CGQ-0600-16	5	1/16
CGQ-0600-05	1.5	1/8	CGQ-0600-17	5	1/8
CGQ-0600-06	1.5	1/4	CGQ-0600-18	5	1/4
CGQ-0600-07	2	1/16	CGQ-0600-19	6	1/16
CGQ-0600-08	2	1/8	CGQ-0600-20	6	1/8
CGQ-0600-09	2	1/4	CGQ-0600-21	6	1/4
CGQ-0600-10	3	1/16			
CGQ-0600-11	3	1/8			
CGQ-0600-12	3	1/4			

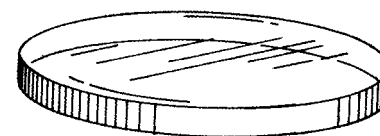

CGQ-0600

QUARTZ PRODUCTS

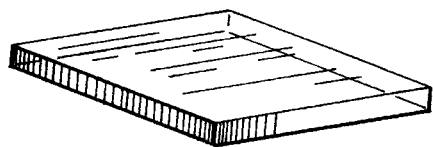

CGQ-0620

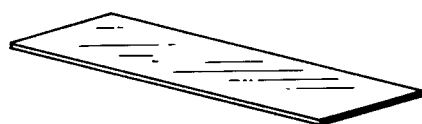

CGQ-0640

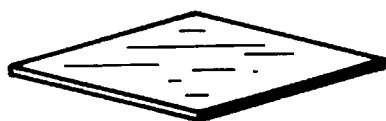

CGQ-0660

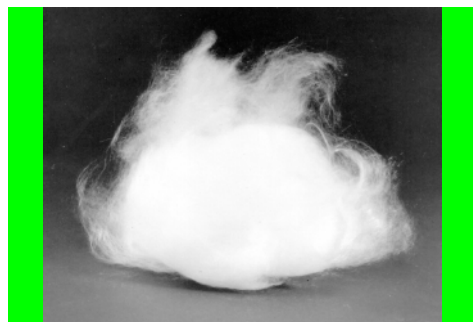

CGQ-0690

CGQ-0620 PLATE GLASS, SQUARE, QUARTZ

Commercial quality ground and polished clear fused quartz plate. Edges have a ground finished on all sizes. **SIZES OTHER THAN THOSE LISTED ARE AVAILABLE. PLEASE CALL FOR DETAILS.**

Part Number	Size (in)	Thickness (in)	Part Number	Size (in)	Thickness (in)
CGQ-0620-01	1 X 1	1/16	CGQ-0620-13	4 X 4	1/16
CGQ-0620-02	1 X 1	1/8	CGQ-0620-14	4 X 4	1/8
CGQ-0620-03	1 X 1	1/4	CGQ-0620-15	4 X 4	1/4
CGQ-0620-04	1.5 X 1.5	1/16	CGQ-0620-16	5 X 5	1/16
CGQ-0620-05	1.5 X 1.5	1/8	CGQ-0620-17	5 X 5	1/8
CGQ-0620-06	1.5 X 1.5	1/4	CGQ-0620-18	5 X 5	1/4
CGQ-0620-07	2 X 2	1/16	CGQ-0620-19	6 X 6	1/16
CGQ-0620-08	2 X 2	1/8	CGQ-0620-20	6 X 6	1/8
CGQ-0620-09	2 X 2	1/4	CGQ-0620-21	6 X 6	1/4
CGQ-0620-10	3 X 3	1/16			
CGQ-0620-11	3 X 3	1/8			
CGQ-0620-12	3 X 3	1/4			

CGQ-0640 MICROSCOPE SLIDES, QUARTZ

Ground and polished clear quartz microscope slides. All sizes are 1mm thickness.

Part Number	Dimensions (mm) / (in.)
CGQ-0640-01	75 x 25 (3" x 1")
CGQ-0640-02	50 x 25 (2" x 1")
CGQ-0640-03	25 x 25 (1" x 1")

CGQ-0660 COVER SLIPS, QUARTZ

Ground and polished clear quartz microscope slide cover slips are ultra-thin (0.25mm) thickness.

Part Number	Dimensions (mm)
CGQ-0660-01	19 x 19

CGQ-0690 QUARTZ WOOL

Useful as high temperature packing in distillation columns or as a bed support for high purity liquid chromatography. Available in fine or coarse porosity. **SOLD IN 1/2lb PACKAGES ONLY.**

Part Number	Description	Fiber Size
CGQ-0690-01	Fine	4-8 Microns
CGQ-0690-02	Coarse	8-15 Microns

QUARTZ PRODUCTS

CGQ-0800T QUARTZ TUBING, CLEAR FUSED, GENERAL ELECTRIC TYPE 214

General Electric Type 214 grade clear fused quartz tubing. Tubing is stocked in 4ft lengths. **PLEASE NOTE: PRICE LISTED IS PER LENGTH OF 4ft TUBING.**

Tubing Tolerances:

Diameter Range (mm)	OD (%)	Out of Round (%)	Wall Thickness (%)	Siding Max % of Wall	Bow in 1200mm	Length (mm)
Up to 5.9	2.5	2	10	10	2	3.2
6 to 35	2	1.5	10	10	2	3.2
35.1 to 70.9	2	1.5	10	10	2	6.4



Part Number	ID (mm)	OD (mm)	Wall (mm)	Part Number	ID (mm)	OD (mm)	Wall (mm)
CGQ-0800T-03	2.0	4.0	1.0	CGQ-0800T-51	17.0	20.0	1.5
CGQ-0800T-04	3.0	5.0	1.0	CGQ-0800T-54	18.0	20.0	1.0
CGQ-0800T-05	4.0	6.0	1.0	CGQ-0800T-55	18.0	21.6	1.8
CGQ-0800T-06	4.0	8.0	2.0	CGQ-0800T-59	19.0	22.0	1.5
CGQ-0800T-07	5.0	7.0	1.0	CGQ-0800T-63	20.0	22.0	1.0
CGQ-0800T-10	6.0	8.0	1.0	CGQ-0800T-65	20.0	24.0	2.0
CGQ-0800T-11	6.0	10.0	2.0	CGQ-0800T-66	20.0	25.0	2.5
CGQ-0800T-13	7.0	9.0	1.0	CGQ-0800T-67	22.0	24.0	1.0
CGQ-0800T-16	8.0	10.0	1.0	CGQ-0800T-68	22.0	25.0	1.5
CGQ-0800T-17	8.0	12.0	2.0	CGQ-0800T-74	24.0	28.0	2.0
CGQ-0800T-19	9.0	11.0	1.0	CGQ-0800T-78	25.0	28.0	1.5
CGQ-0800T-23	10.0	12.0	1.0	CGQ-0800T-82	26.0	29.0	1.5
CGQ-0800T-25	10.0	14.0	2.0	CGQ-0800T-86	27.0	30.0	1.5
CGQ-0800T-27	11.0	13.0	1.0	CGQ-0800T-90	28.0	31.0	1.5
CGQ-0800T-30	12.0	14.0	1.0	CGQ-0800T-91	28.0	32.0	2.0
CGQ-0800T-31	12.0	15.0	1.5	CGQ-0800T-98	32.0	35.0	1.5
CGQ-0800T-32	12.0	16.0	2.0	CGQ-0800T-101	34.0	37.0	1.5
CGQ-0800T-34	13.0	15.0	1.0	CGQ-0800T-102	34.0	38.0	2.0
CGQ-0800T-35	13.0	16.0	1.5				
CGQ-0800T-38	14.0	16.0	1.0				
CGQ-0800T-40	14.0	18.0	2.0				
CGQ-0800T-47	15.0	17.0	1.0				
CGQ-0800T-43	15.0	18.0	1.5				
CGQ-0800T-46	16.0	18.0	1.0				
CGQ-0800T-50	17.0	19.0	1.0				

PLEASE NOTE: QUARTZ TUBING IS AVAILABLE IN SIZES OTHER THAN THOSE LISTED ABOVE. PLEASE CONTACT OUR TECHNICAL SERVICE DEPARTMENT FOR DETAILS.

CGQ-0801 QUARTZ ROD, CLEAR FUSED, GENERAL ELECTRIC 214

General Electric Type 214 clear fused quartz rod. Rod is stocked in 4ft lengths. **PLEASE NOTE: PRICE LISTED IS PER LENGTH OF 4ft Rod.**

Part Number	Dia. (mm)	Tolerance Dia. (mm)
CGQ-0801-01	2	± 0.20
CGQ-0801-02	3	± 0.30
CGQ-0801-03	4	± 0.15
CGQ-0801-04	5	± 0.15
CGQ-0801-05	6	± 0.15
CGQ-0801-06	7	± 0.30
CGQ-0801-07	8	± 0.12
CGQ-0801-08	9	± 0.14
CGQ-0801-09	10	± 0.15
CGQ-0801-10	12	± 0.18



CGQ-0801